

SPECIFICATION

Adesso Inc..

Free Declaration

Please read through the manual carefully before using the product and operate it according to the manual. It is advised that you should keep this manual for future reference.

Do not disassemble the device or remove the seal label from the device, doing so will void the product warranty provided by Adesso Inc..

All pictures in this manual are for reference only and actual product may differ. Regarding to the product modification and update, Adesso Inc.. reserves the right to make changes to any software or hardware to improve reliability, function, or design at any time without notice. The information contained herein is subject to change without prior notice.

The products depicted in this manual may include software copyrighted by Adesso Inc..or third party. The user, corporation or individual, shall not duplicate, in whole or in part, distribute, modify, decompile, disassemble, decode, reverse engineer, rent, transfer or sublicense such software without prior written consent from the copyright holders.

This manual is copyrighted. No part of this publication may be reproduced, distributed or used in any form without written permission from Adesso.

Adesso Inc.. reserves the right to make final interpretation of the statement above.

Adesso Inc.. 160 Commerce Way Walnut, CA 91789

<http://www.adesso.com>

Content

Chapter1 Getting Started.....	7
Introduction	7
Features	7
Applications.....	7
Optics	9
Structure Size	10
Data Interface	14
Chapter 2 Module Parameter	16
Physical Parameter	16
Performance Parameter	17
Depth of Field	18
Ambient Parameter	18
Chapter 3 System Setting.....	19
Introduction	19
Factory Default.....	20
Check the Version.....	20
Send Enter Setup Barcode.....	21
Scanning Mode	22
Trigger Timeout	23
Data transmission speed	24
Buzzer Setting (default)	26
Chapter 4 Communication Setting	27
Introduction	27

USB Communication Mode	27
Country/language Choose	27
PS2 Interface.....	30
USB COM Port Emulation.....	30
RS232 Interface	30
Baud rate.....	31
Chapter 5 Data Edition.....	32
Introduction	32
Terminating Character Setting.....	33
Code ID Setting	34
Convert Case.....	35
Custom Prefix and Suffix	36
Invisible Character.....	38
Chapter 6 Symbologies	42
Introduction	42
EAN-8.....	42
EAN-13	43
Codabar	46
Code 11	47
Code 39	47
Code 93	49
Code 128.....	50
GS1 DataBar Limited (RSS Limited)	50

GS1 DataBar Omnidirectional (RSS Omnidirectional)	51
UPC-A	52
UPC-E.....	53
Interleaved 2 of 5	55
Industrial 2 of 5	55
Standard 2 of 5	56
Matrix 2 of 5.....	56
MSI	57
Plessey	57
Chapter 7Serial Commands.....	59
Introduction	59
Command Analysis.....	60
Save Command.....	60
Command Feedback Setting.....	61
Buzzer feedback Setting.....	61
Example Analysis	62
Chapter 8 Appendix	65
Appendix A	65
Appendix B (ASCII Table)	66
Appendix C (Function Key Table)	72

Chapter1 Getting Started

Introduction

NT-C05H is a sort of embedded 1D CCD module. This module uses the domestic leading CCD imaging technology with USB, TTL-RS232, PS2 interface, support manual 1D codes.

The module is special for OEM application with 32CPU processor can up to 300scans. Compact size can easily be embedded to all kinds of equipment, integration component to increase the stability and reliability.

Features

- Linear barcode scanning: Fast and easy to scan print code, paper code, screen code. It even has great performance for damaged, clumped, stain codes have great performance.
- Compact design: With less than 12MM height, the module can be easily embedded to equipment .
- Multiple interfaces: Manual USB port, TTL-RS232, PS2, support POS machine and Android system.
- Integration: High quality CPU ensures fast and accurate scans.

Applications

Barcode scanner, wireless collector, smart locker, self-service equipment, lottery machine, Health-care terminal and mobile payment.

NT-C05H General Requirements

ESD Protection: ESD protection has been taken into account when designing the NT-C05H and the engine is shipped in ESD safe packaging. Always care when handing the engine out side its packaging .Be sure grounding wrist straps and properly grounded work areas are used.

Dust and dirt:The NT-C05H must be sufficiently enclosed to prevent dust particles from gathering on the imager and lens. Dust and other external containers will eventually degrade the engine's performance.

Ambient Environment:To ensure good performance for NT-C05H,the environmental requirements should met :Working temperature:-20°C~50°C,Storage temperature:-20°C

~50°C, Humidity:5%-95%(non-condensing)

Thermal Considerations :Electronic components in the NT-C05H will generate heat during the course of their operation. Operating the NT-C05H in continuous mode for an extended period may cause temperature to rise on CIS and decoder chips. Overheating can degrade image quality and affect scanning performance.Given that,the following precautions should be taken into consideration when integrating the NT-C05H:

- 1.Reserve the sufficient space for good air circulation in the design.
- 2.Avoid Wrapping the NT-C05H with thermal insulation materials such as rubber.

Installation Orientation:The following figure illustrates a front view of the NT-C05H after installation, with the engine's decoder board on the top,and the illumination and lens on the front.

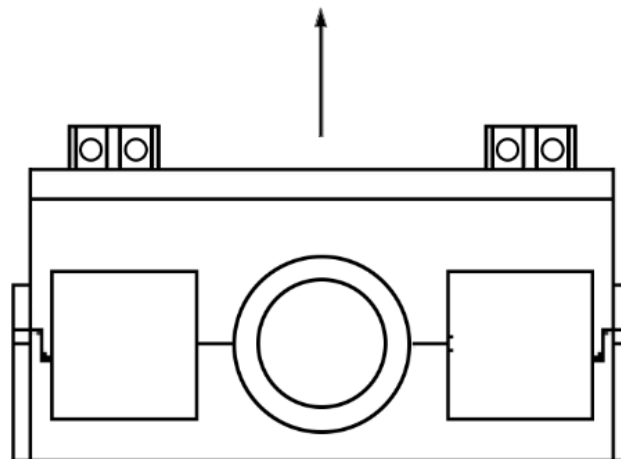

Optics

Window Placement

The window should be positioned properly to let the illumination and the aiming beams pass through as much as possible and no reflections back into the engine(reflections can degrade the reading performance).

Window should be mounted close to the front of the engine(parallel).The maximum distance is measured from the front of the engine housing to the farthest surface of the window.In order to reach the better reading performance,the distance from the front of the engine housing to the furthest surface of the window should not exceed 1.5mm and the distance from the front of the engine housing to the nearest surface of the window should not exceed0.5mm.

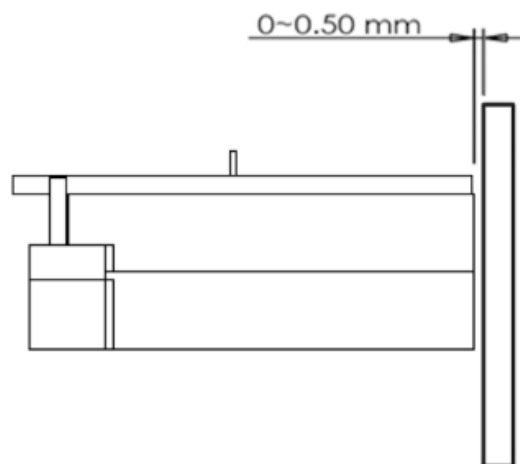

If the window is required to be in a tilted position,the above distance requirements should be met and tilt angle should ensure no reflections back into the lens.

Window Material and Color

Illumination wavelengths and CIS's responsiveness (mainly to wavelengths of red light) should be taken into consideration when choosing window material and color, in order to achieve the possible highest spectral transmission, lowest haze level and homogeneous refractive index. It is suggested to use PMMA or optical glass with spectral transmittance over 95% and haze less than 1%. Whenever to use an anti-reflection coating or not depends on the material and application needs.

Window Size

The window must not block the field of view and should be sized to accommodate the aiming and illumination envelopes shown below.

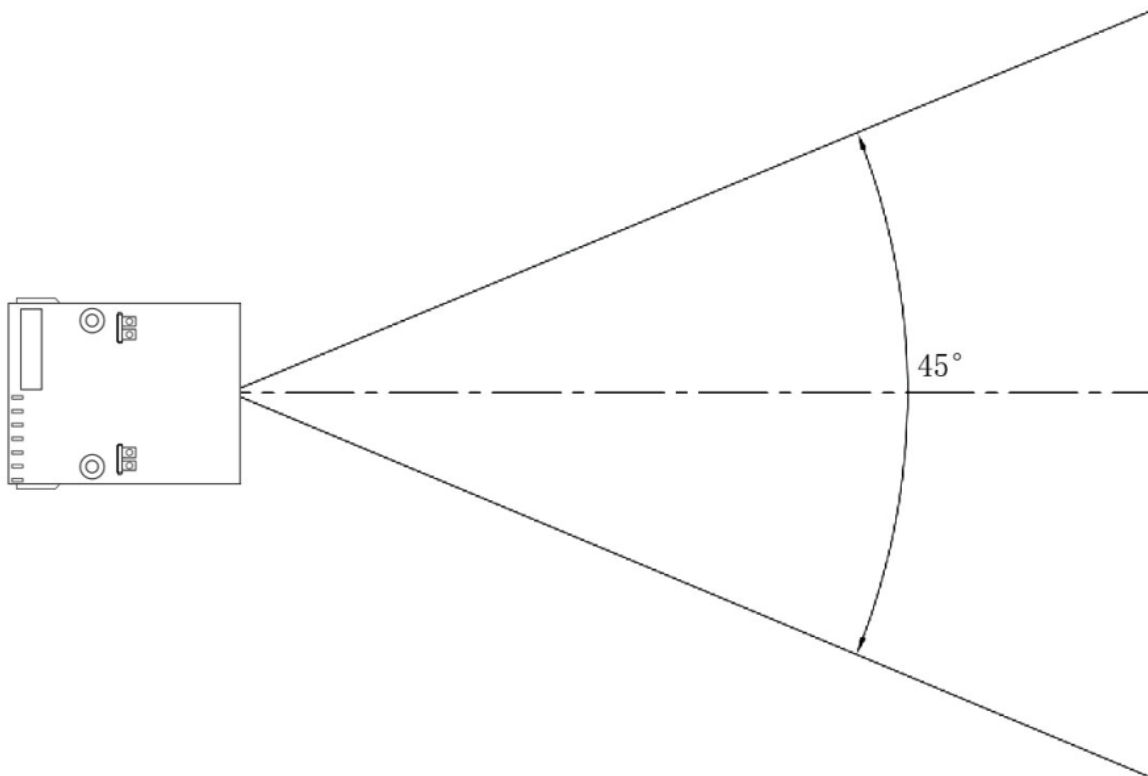

Structure Size

With integrate design users can connect the terminal equipment by FPC or development board. The illumination below show the mechanical mounting dimensions for the NT-C05H. The structural design should be leave some space between components.

Front View (unit: mm)

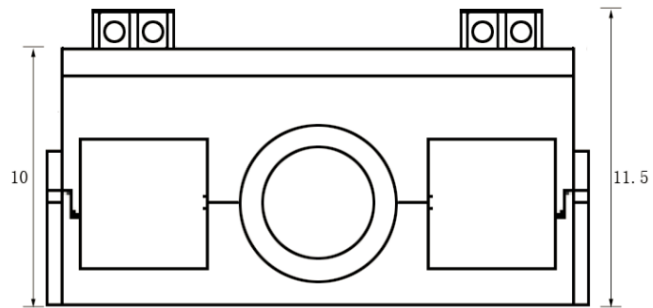

Top View (unit: mm)

Side View (unit: mm)

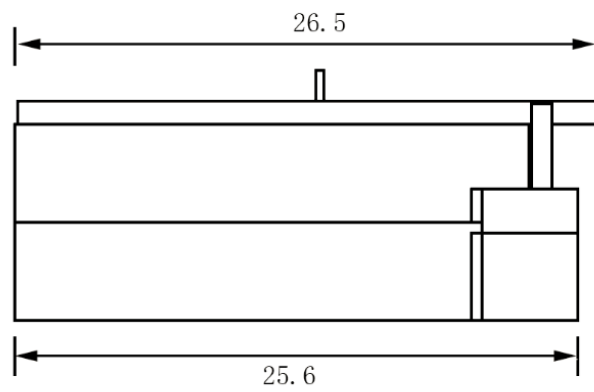

Bottom View (unit: mm)

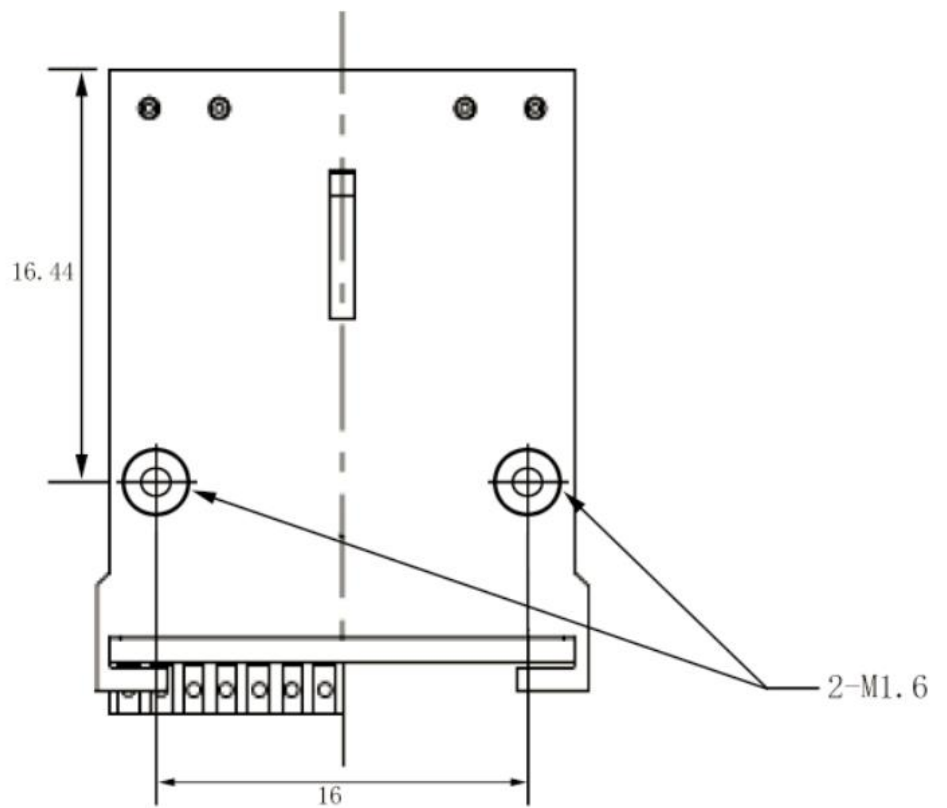

Interface Definition

The table below listed the names and signal definition of 12PIN of NT-C05H.

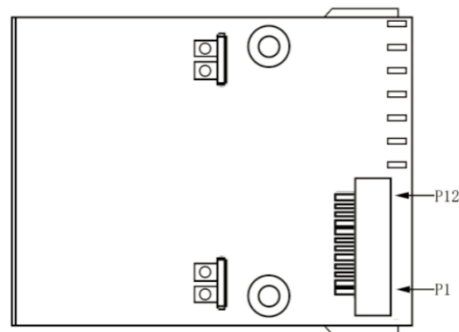

PIN#	Signal	I/O	Definition
1	NC	-	Not Connected
2	VCC	-	Power supply
3	GND	-	Power-supply ground
4	RX	Input	TTL-RS232 Receiving
5	TX	Output	TTL-RS232 Transmission
6	D-/HOST DATA	Input/Output	USB_D- Signal/PS2_HOST DATA
7	D+/HOST CLK	Input/Output	USB_D+ Signal/PS2_HOST CLK
8	KB DATA	-	PS2_KB DATA
9	Buzz	Output	Beeper Output.
10	LED	Output	Decode LED
11	KB CLK	-	PS2_KB CLK
12	KEY	Input	To trigger the input signal, keep 20ms signal

Data Interface

NT-C05H must connect a host to operate, host can be PC host, POS terminal or Android terminal.

USB Interface

Pin No.	Function
1	Vcc
2	D-
3	D+
4	GND

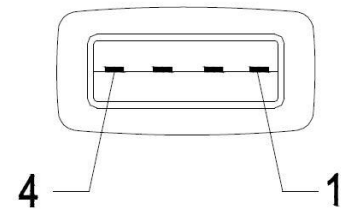

RS232 Interface

Pin No.	Function
2	TXD
3	RXD
5	GND
9	Vcc/+5V
Power Lead	Vcc/+5V

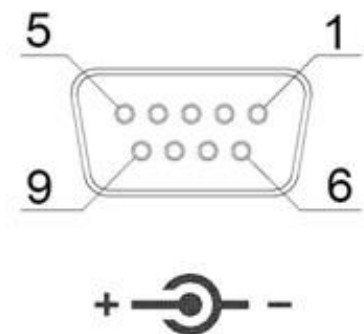

PS2 Interface

Mini DIN HOST MALE

Pin No.	Function
1	HOST DATA
3	GND
4	Vcc(+5V)
5	HOST CLK

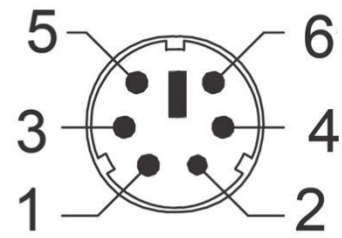

Mini DIN KB FEMALE

Pin No.	Function
1	KB DATA
3	GND
4	Vcc(+5V)
5	KB CLK

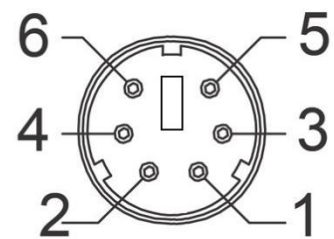

Chapter2 Module Parameter

Physical Parameter

Physical Parameter	
Device weight	<6g
Device dimension	24mm L* 25.5mm W * 12mm H
Cable Length	1800mm
Interface	USB/TTL-RS232/PS2
Test Board	Yes
Connector	FFC 12pin pitch 0.5

Performance Parameter

Performance Parameter	
Light Source	Visible 632nm red light
Sensor	Linear CCD Sensor
Processor	ARM32-bit
Pixel	2500dpi
Resolution	$\geq 4\text{mil}/0.1\text{mm}@PCS90\%$
Depth of Field	3-50CM
Decode Speed	300 times/sec
Scanning Mode	Trigger button,Continuous ,Command trigger
Scan Angles	<i>Test Conditions : CODE39,10mil/0.25mm,PCS90%</i>
	Pitch: $\pm 60^\circ$
	Roll: $\pm 30^\circ$
	Skew: $\pm 60^\circ$
Power Supply	DC 3.3V-5V
Current	110mA (Work current) ; 30mA (standby current)
Print Contract	$\geq 25\%$
Ambient	100,000Lux Max
Decode Capacity	EAN-8, EAN-13, Codabar, CODE11, CODE 39, CODE 93, CODE128, China Post, GS1-128, GS1 Limited, GS1 Omnidirectional, UPC-A, UPC-E, ISBN/ISSN, ISBT , Interleaved 2 of 5, Matrix 2 of 5, Industrial 2 of 5 , MSI, Plessey, ITF14.

Depth of Field

Decode Capacity			
Type of Code	Code Dimension	Nearest	Farthest
Code 39	0.1mm(4mil)	80mm	130mm
Code 39	0.15mm(6.0mil)	60mm	180mm
Code 39	0.25mm(9.8mil)	30mm	270mm
Code 39	0.5mm(20mil)	30mm	470mm
Code 39	1.0mm(40mil)	130mm	700mm
UPC	0.26mm(10mil)	30mm	270mm
EAN 13	0.33mm(13.0mil)	30mm	320mm

Test condition: 25°C indoor, ambient illumination 200LUX, PCS=0.9

Ambient Parameter

Ambient Parameter	
Operating Temperature	-20°C to 50°C
Storage Temperature	-40°C to 70°C
Relative Humidity	5% to 95% (non-condensing)
Drop test	1.2 meter
Temperature test	30 minutes for high Temp., 30 minutes for low Temp.,
Highest temp	60°C
Lowest temp	-20°C
Shock resistance	10H@125RPM

Chapter3 System Setting

Introduction

The scanner can be configured by scanning programming barcodes.



Manual Introduction

Manual scanning mode, please follow the scanning steps:

1. Press and hold the trigger button, then the light is activated, and appear the red aiming light and the white led light.
2. Aim the center of the codes by red aiming light, to move the scanner between the codes to find the best scanning distance.
3. Decode successfully when you hear the buzzer sound and the red light will be off, the codes will be transmitted to the host.

Note: During scanning the same series codes, you will find there will be a highly success rate between the scanner and the codes in some distance, this refers to the best reading distance.

Factory Default

All modules have a “factory default ”programming codes,Scanning the following barcode can restore the scanner to the factory defaults.

You may need to reset your scanner when:

1. scanner is not properly configured so that it fails to decode barcodes;
2. you forget previous configuration and want to avoid its impact;
3. functions that are rarely used have been enabled for the time being.

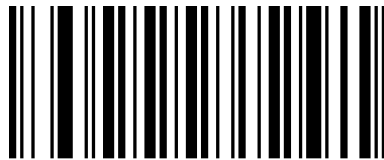

000B0

Factory Default

Check the Version

Scanning the code to check the scanner version.



000A0

Check the Version

Send Enter Setup Barcode

Enter Setup can be sent to the host. When you set < Enter Setup Barcode Permission>successfully, the content of Enter Setup Barcode will be sent to the host. When you set < Enter Setup Barcode Forbidden>successfully, the content of Enter Setup Barcode will not be sent to the host. The Default is < Enter Setup Barcode Forbidden>.

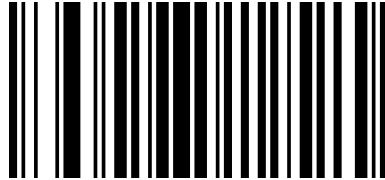

02501

Enter Setup Barcode Permission

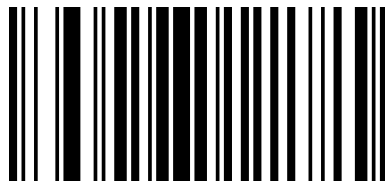

02500

Enter Setup Barcode Forbidden

Scanning Mode

Manual mode

Manual Mode (default): Users can setup the scan mode according to their needs. A trigger pull activates a decode session. The decode session continues until the barcode is decoded or the trigger is released or the decode session timeout expires.

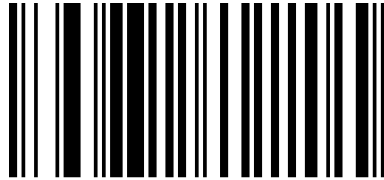

013300

Manual Mode

Continuous Mode

Continuous Mode: Users can setup an Auto Continuous Mode. When you setup this mode successfully, the red light of the scanner will always on, and will read it automatically when the barcodes pass by. When you meet with the same barcode, you need to remove to reread this barcode

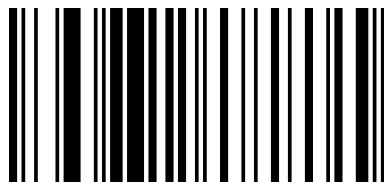

013304

Auto Continuous Mode

Users can also setup a Trigger Delay Mode, when you setup this mode successful, the red light of the scanner will on 3 seconds, and will off when you read the barcode after 3 second. The red light will turn off when you read the barcode successfully.

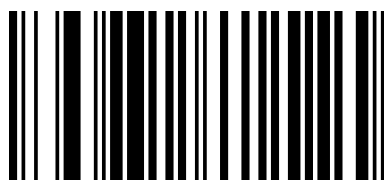

013301

Trigger Delay Mode

Trigger Timeout

When users use <Trigger Delay Mode>, you can setup the timeout according to your needs, the default timeout is 3 seconds, the timeout ranges from 1s to 9.9s.

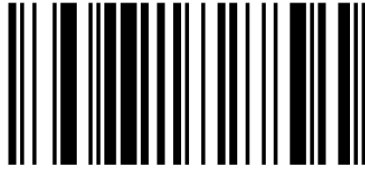

023510

set timeout to 1S

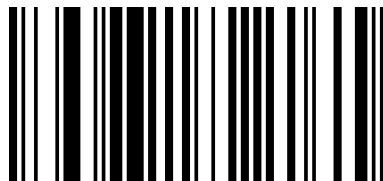

023530

set timeout to 3S



023550

set timeout to 5S



023599

set timeout to 9.9S

Data transmission speed

The scanner can control the transmission speed by scanning the programming codes. For some non-standard Windows USB interface (i.e. through PS2 to connect USB interface), this interface can be cut down the transmission speed to guarantee the integrity and stability of the barcode scanner. The default is to close the USB high speed transmission, by using the <full speedtransmission mode>.

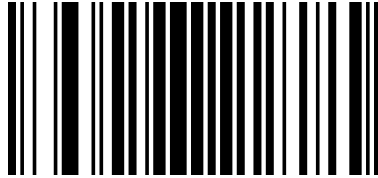

02301

USB High Speed

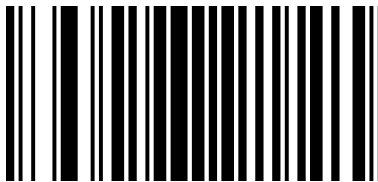

02302

USB Full Speed

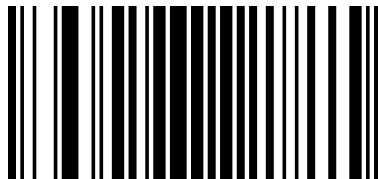

02300

To close USB High Speed Transmission

Users can setup the speed of the USB device.

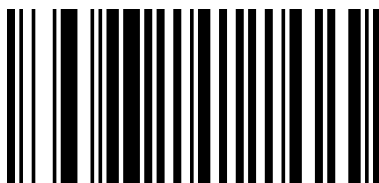

001500

High Transmission Speed

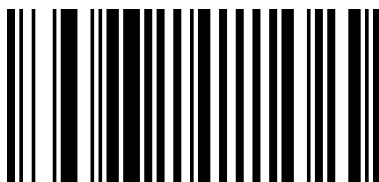

001502

Middle Transmission Speed

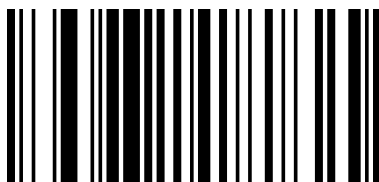

001504

Slow Transmission Speed

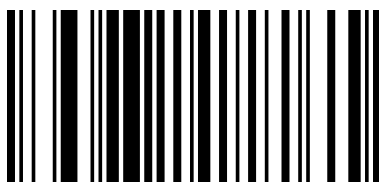

001506

Slowest Transmission Speed

Buzzer Setting (default)

When users read a barcode successfully, you will hear buzzer sound once, and also you can turn it on or off according to your needs.

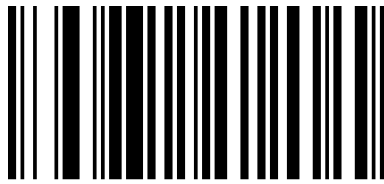

014201

Buzzer on*

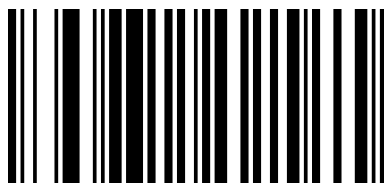

014200

Buzzer off

Chapter4 Communication Setting

Introduction

NT-C05H support USB, USB-COM, RS232 interface to communicate with the host device,Users can set scanner functions by scanning programming codes.

USB Communication Mode

USB keyboard mode by default.

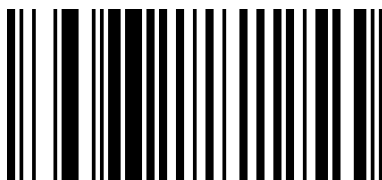

000602

USB Keyboard

Country/language Choose

Keyboard layouts vary from country to country. All supported keyboard types are listed below.



0005000

U.S./China (American English)

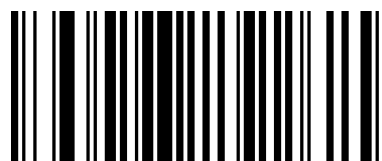

0005001

Canada (French)

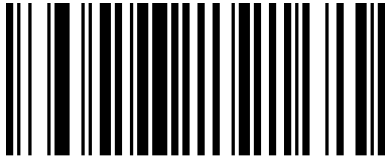

0005002

Netherland (Dutch)

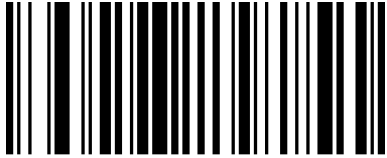

0005004

Argentina (Spanish)

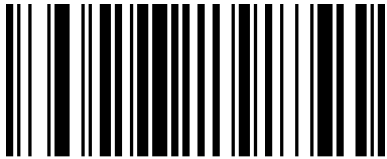

0005006

Denmark (Danish)



0005008

Italy (Italian)

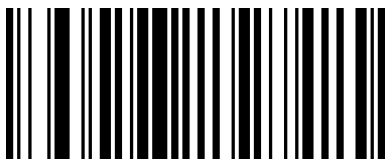

0005010

Germany (German)

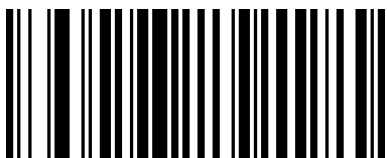

0005012

Sweden/Finland (Swedish/Finnish)

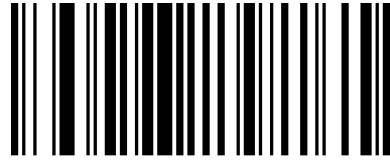

0005003

Spain (Spanish)

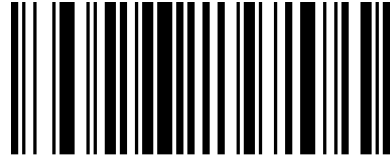

0005005

Brazil (Portuguese)

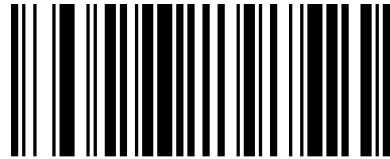

0005007

UK (British English)

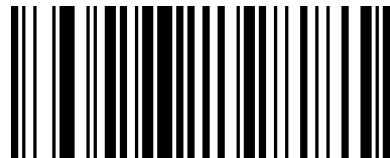

0005009

France (French)

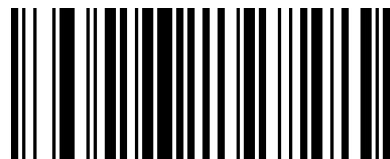

0005011

Norway (Norsk)

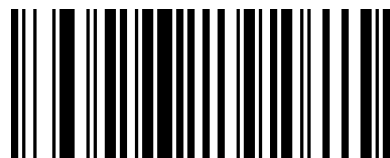

0005013

Slovakia (Slovak)

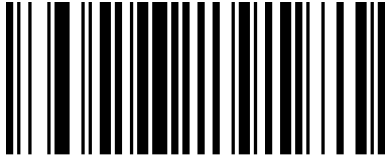

0005014

Portuguesa (Portuguese)

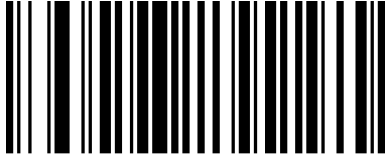

0005016

Belgium (Dutch)

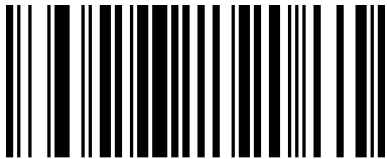

0005018

Turkish-Q

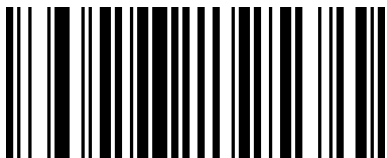

0005020

Switzerland (German/French)

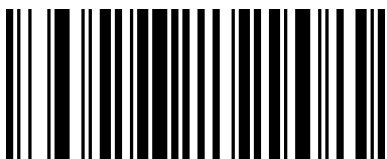

0005022

Hungary (Hungarian)

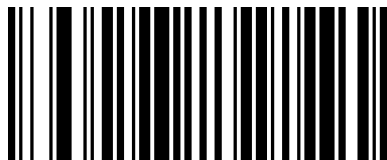

0005024

Russia (Russian)

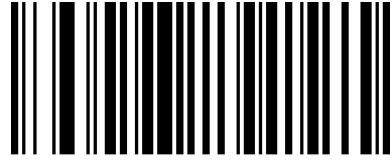

0005015

Czech (Czech)

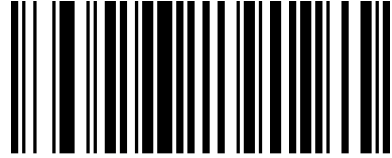

0005017

Turkish-F

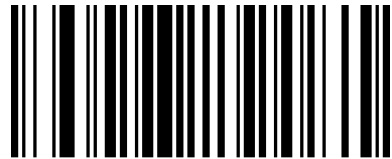

0005019

Poland (Polish 214)

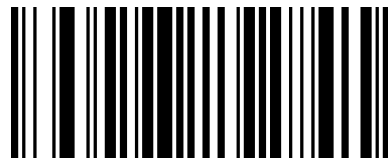

0005021

Croatia (Srb-Crt)

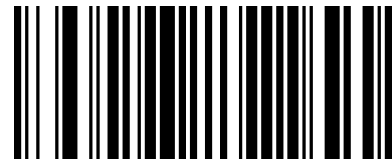

0005023

Japan (Japanese)

PS2 Interface

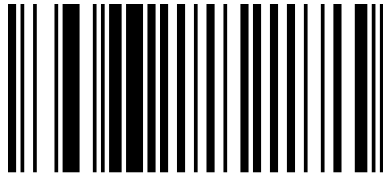

000600

PS2 Interface PS2

USB COM Port Emulation

This feature allows the host to receive data in the way as a serial port does. However, you need to set communication parameters on the scanner to match the Host requirements. A driver is required for this feature.

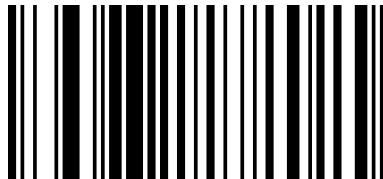

000603

USB COM Port Emulation

Notice: In USB COM Port Emulation, the port protocol parameter of the scanner can match the port parameter of application of the host automatically.

RS232 Interface

Serial communication interface is usually used to connect the scanner to a host device (like PC, POS). When the scanner is connected to a host device through its RS-232 interface, you need to set communication parameters to match the host device.

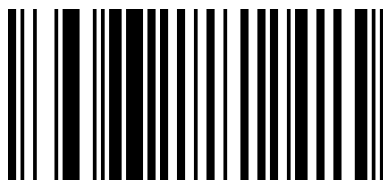

000601

RS232 Serial Port

Baud rate

Baud rate is the number of bits of data transmitted per second. Set the scanner's baud rate to match the host requirements. All supported baud rate are listed below.

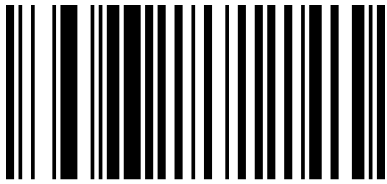

000701
600bps

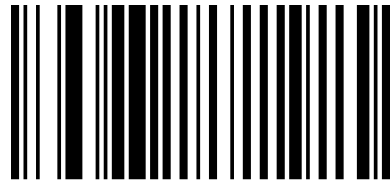

000702
1200bps

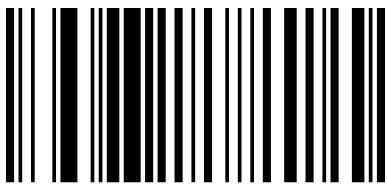

000703
2400bps

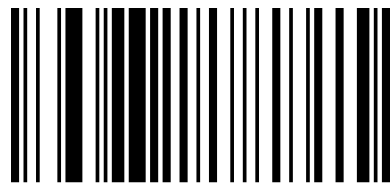

000704
4800bps

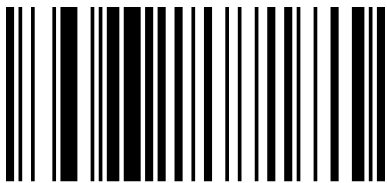

000705
9600bps*

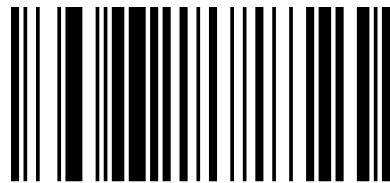

000706
19200bps

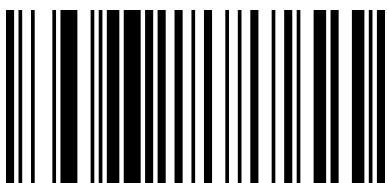

000707
38400bps

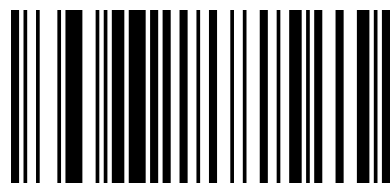

000708
57600bps

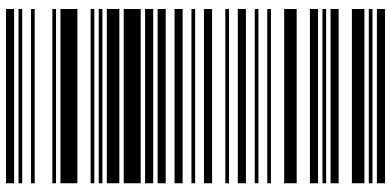

000709
115200bps

Chapter 5 Data Edition

Introduction

After a successful barcode read, a string containing numbers, letters or symbols will be returned. In real applications, barcode data may be found insufficient for your needs. You may wish to include additional information such as barcode type, data acquisition time or delimiter in data being scanned. Adding extra information to printed barcodes does not seem like a sensible solution since that will increase the barcode size and make them inflexible. Instead, we come up with the idea of appending prefix and suffix to the data without making any change to barcodes. We will show you how to conduct the configuration in the following sections.

Note: Customized data: <Prefix><Data><Suffix><Terminating Character>

Terminating Character Setting

Corresponding terminating character can be added during using the Module to meet the user's requirements

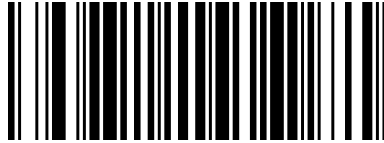

0212@r

Add Return CR*



0212@n

Add Newline LF*

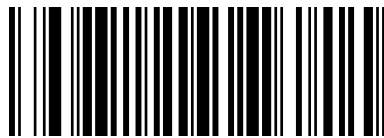

0213@r\n

Add Return and Newline

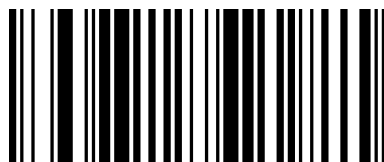

0210@

None

Code ID Setting

Users usually need to know barcode type in the process of scanning, you can use Code ID prefix to recognize the barcode type. Please read “Appendix A” for the reference of the Code ID corresponding barcode type. No Code ID default setting.

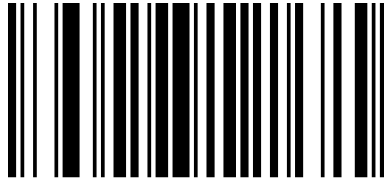

01400

Enable Code ID*

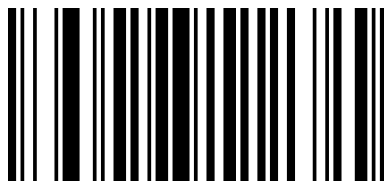

01401

Disable Code ID (prefix)

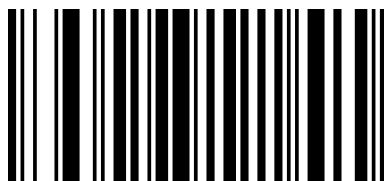

01402

Enable Code ID (suffix)

Convert Case

This parameter is valid when the Covert Case is set. When the Convert All to Lower Case feature is enabled, barcode data “aBC123” is transmitted as “abc123”.

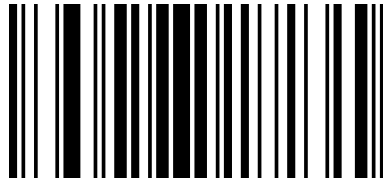

02510

No Case Conversion*

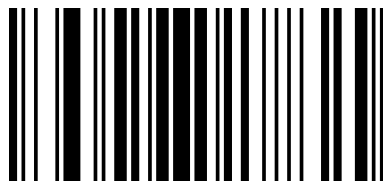

02511

Convert All to Upper Case

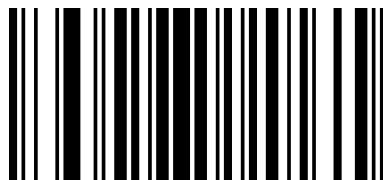

02512

Convert All to Lower Case

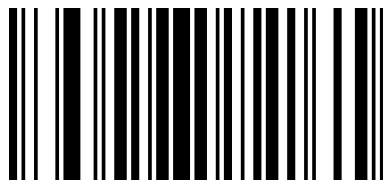

02513

Invert Upper and Lower Case Characters

Custom Prefix and Suffix

Users can custom the prefix and suffix of the output code for your requirements. For example, when you add prefix “VC” to barcode “123”, the host will receive “VC123”. When you add suffix “DE” to barcode “123”, the host will receive “123DE”.

Set Custom Prefix

To set a custom prefix, scan the “Add Prefix” barcode first, then scan the corresponding barcode in "Appendix B" for your requirement, at last setting is done.

Note: A custom prefix cannot exceed 32 characters.

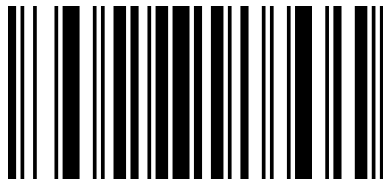

02240

Add Prefix

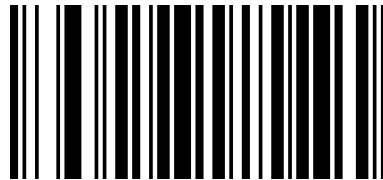

02220

Clear All Prefix

Set Custom Suffix

To set a custom suffix, scan the "Add Suffix" first, then scan the corresponding barcode in "Appendix B" for your requirement, at last setting is done.

Note: A custom suffix cannot exceed 32 characters.

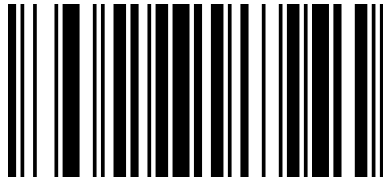

02241

Add Suffix

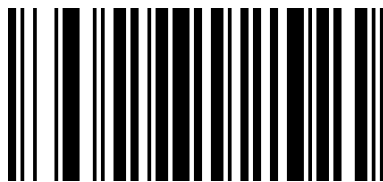

02200

Clear All Suffix

Note: When you clear suffix, you will not clear the terminating character.

Quit setting prefix and suffix

Scan the "Quit Adding the Prefix&Suffix" programming codes when you don't want to add the prefix&suffix after the "Add Prefix/Suffix" being scanned.

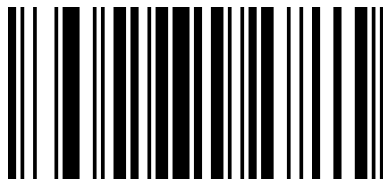

02242

Quit Adding the Prefix&Suffix

Invisible Character

Invisible Character can be setup as user's requirements. For example,code "123456",When "12" is set up as invisible character, "3456" will be the data host receipt. When "56" is set up as invisible character, "1234" will be the data host receipt.

Invisible Prefix Character

Corresponding invisible prefix character can be setup as user's requirements.

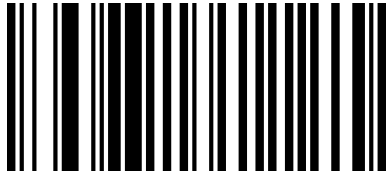

023401

Invisible Prefix 1Character

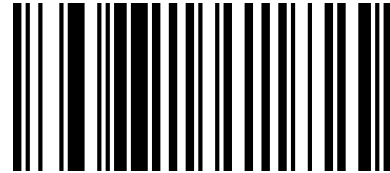

023402

Invisible Prefix 2Character

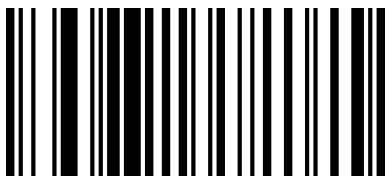

023403

Invisible Prefix 3Character

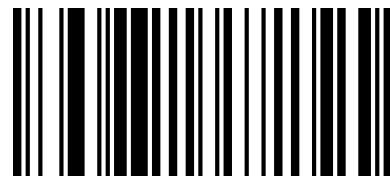

023405

Invisible Prefix 5Character

Clear Invisible Prefix Character



023400

Clear Invisible Prefix Character

Invisible Suffix Character

Corresponding invisible suffix character can be setup as user's requirements.

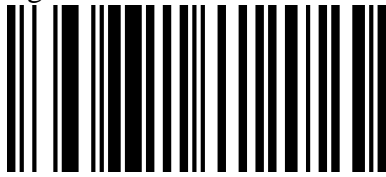

023301

Invisible suffix 1Character

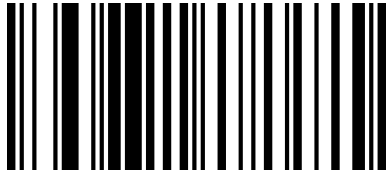

023303

Invisible Suffix 3Character

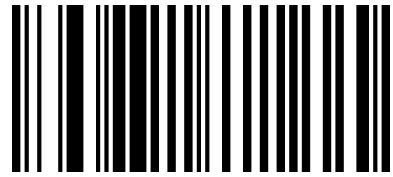

023302

Invisible Suffix 2Character

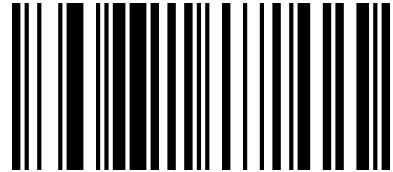

023305

Invisible Suffix 5Character

Clear Invisible Suffix Character

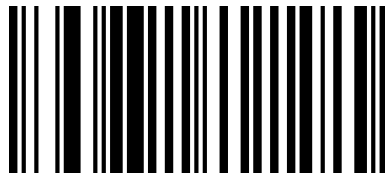

023300

Clear Invisible Suffix Character

Middle Digits Invisible

User can scan the programming codes below to set the middle digits invisible. First, Scan <From the Mth digits >to start setting, then scan<invisible N digits>to finish setting. For example, when you need to set “56” in barcode “12345678”, first, scan <From the 4th digits>, then scan<invisible 2 digits>, the Host device will the data as “123478”

From the Mth digits

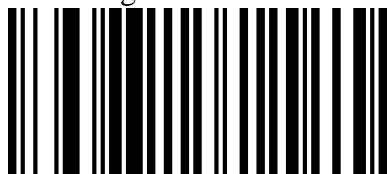

024001

From the first digit

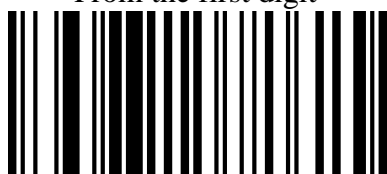

024003

From the 3rd digits



024005

From the 5th digits

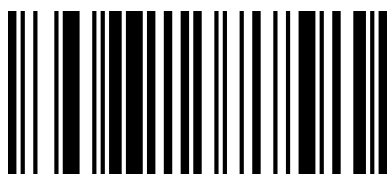

024007

From the 7th digits

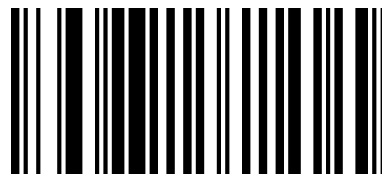

024002

From the 2nd digits

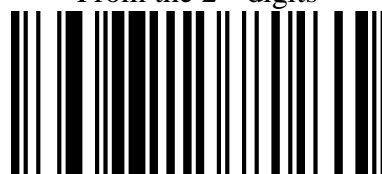

024004

From the 4th digits

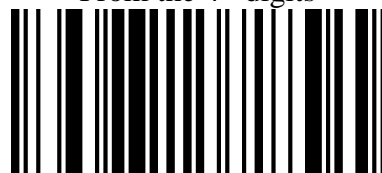

024006

From the 6th digits

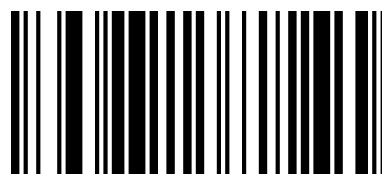

024008

From the 8th digits

The Few Digits Invisible

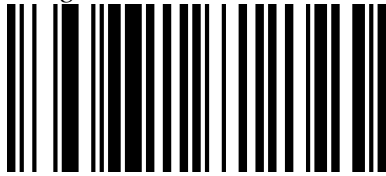

023901

Invisible 1 digit

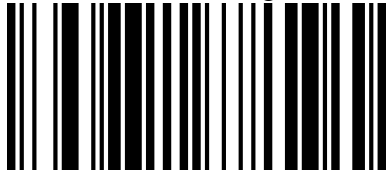

023903

Invisible 3 digits

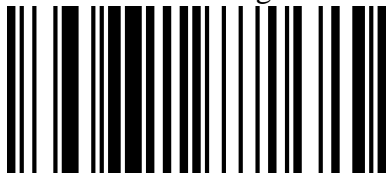

023905

Invisible 5 digits

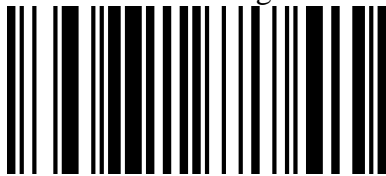

023907

Invisible 7 digits

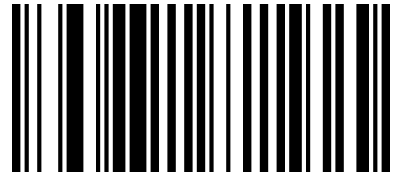

023902

Invisible 2 digits

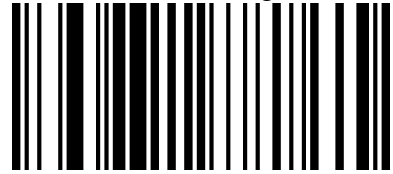

023904

Invisible 4 digits

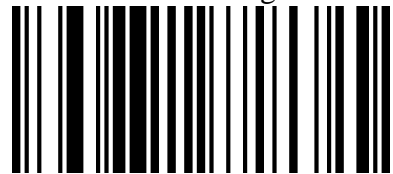

023906

Invisible 6 digits

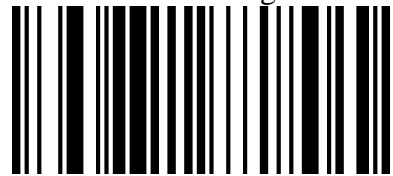

023908

Invisible 8 digits

Clear Digits Invisible

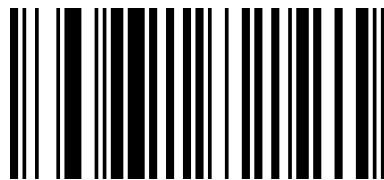

023300

Clear Digits Invisible

Chapter 6 Symbologies

Introduction

Every symbology (barcode type) has its own unique attributes. This chapter provides programming barcodes for configuring the scanner so that it can identify various barcode symbologies. It is recommended to disable those that are rarely used to increase the efficiency of the scanner.

EAN-8

Enable/Disable EAN-8

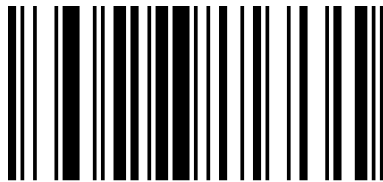

00371

EnableEAN-8*

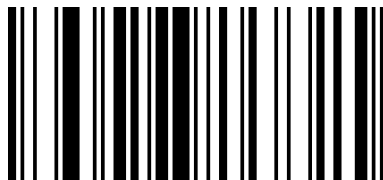

00370

Disable EAN-8

Transmit Check Digit

EAN-8 is 8 digits in length with the last one as its check digit used to verify the integrity of the data. The default mode opens “transmit EAN-8 Check Digit”. Users can scan the code below to choose it.

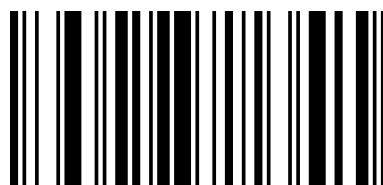

00571

Transmit EAN-8 Check Digit

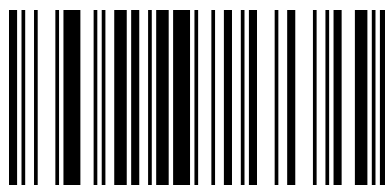

00570

Do Not Transmit EAN-8 Check Digit

Add-On Code

An EAN-8 barcode can be augmented with a two-digit or five-digit add-on code to form a new one. In the examples below, the part surrounded by blue dotted line is an EAN-8 barcode while the part circled by red dotted line is add-on code. The default mode opens “Disable Add-on Code”. Users can take “Add-On Code Setting” for reference.



EAN-13

Enable/Disable EAN-13

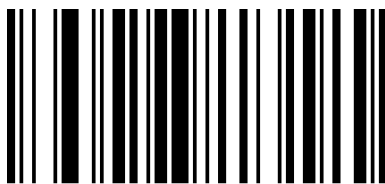

00361

Enable EAN-13

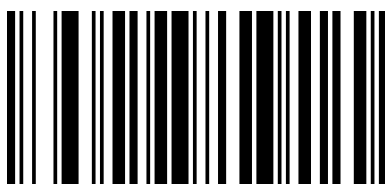

00360

Enable EAN-13

Transmit Check Digit

EAN-13 is 13 digits in length with the last one as its check digit used to verify the integrity of the data. The default mode opens “Transmit EAN-13 Check Digit”. Users can choose to send it or not.

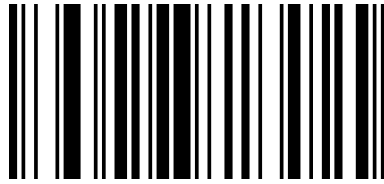

00461

Transmit EAN-13 Check Digit*



00460

Do Not Transmit EAN-13 Check Digit

Add-On Code

An EAN-13 barcode can be augmented with a two-digit or five-digit add-on code to form a new one. In the examples below, the part surrounded by blue dotted line is an EAN-13 barcode while the part circled by red dotted line is add-on code. Users can take “Add-On Code Setting” for reference.



EAN-13 Transfer to ISBN

The International Standard Book Number (ISBN) is a unique numeric commercial book identifier. The ISBN is 13 digits long, When you scan “EAN-13 Transfer to ISBN”programming code, the output code will be 10 digits long ISBN code. The default closes this mode.

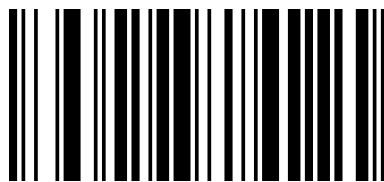

00481

Enable EAN-13 Transfer to ISBN

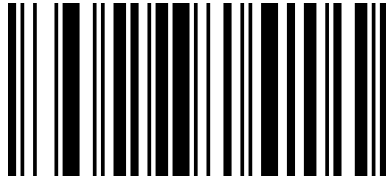

00480

Disable EAN-13 Transfer to ISBN

EAN-13 Transfer to ISSN

An International Standard Serial Number (ISSN) is used to uniquely identify a serial publication. When you scan “EAN-13 Transfer to ISSN” programming code, the output code will be 10 digits long ISSN code. The default closes this mode.

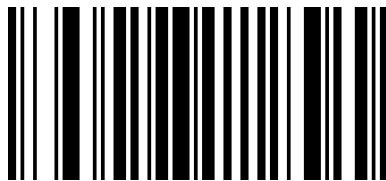

01501

Enable EAN-13 Transfer to ISSN

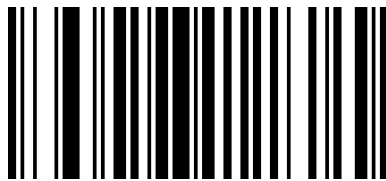

01500

Disable EAN-13 Transfer to ISSN

Codabar

Enable/Disable Codabar

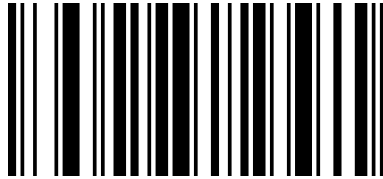

00851
Enable Codabar

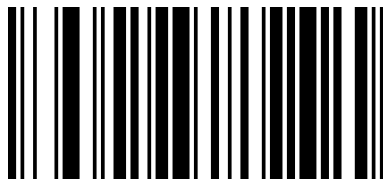

00850
Disable Codabar

Start/Stop Characters

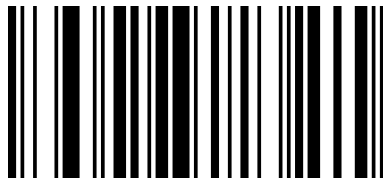

00861
Enable Codabar Start/Stop Characters



00860
Disable Codabar Start/Stop Characters*

Code 11

Enable/Disable Code 11

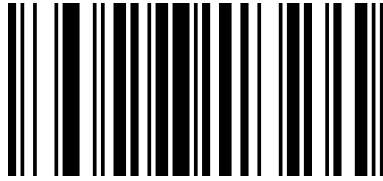

01261

Enable Code 11

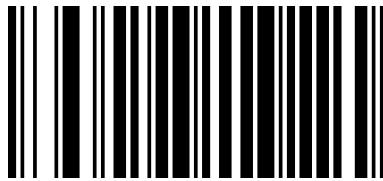

01260

Disable Code 11

Code 39

Enable/Disable Code 39

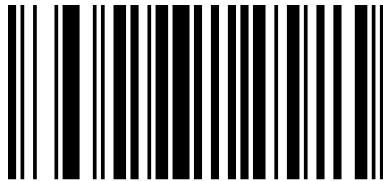

00221

Enable Code 39*



00220

Disable Code 39

Start/Stop Characters

There is a code like this <*Code39*>, These hash keys refers to Start and Stop, you can set it whether the start and stop character transmit with the barcode.

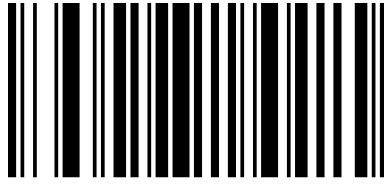

00281

Enable Code39Start/Stop Characters

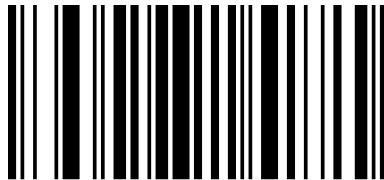

00280

Disable Code39Start/Stop Characters *

Enable/Disable Code 39 Full ASCII

The module can be configured to identify all ASCII characters by scanning the appropriate barcode below.

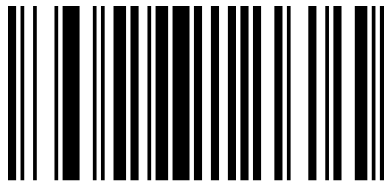

00231

Enable Code 39 Full ASCII*

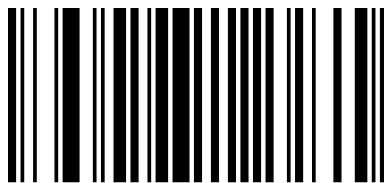

00230

Disable Code 39 Full ASCII

Code 93

Enable/Disable Code 93

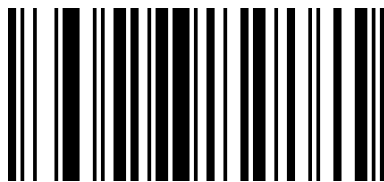

00621

Enable Code 93*

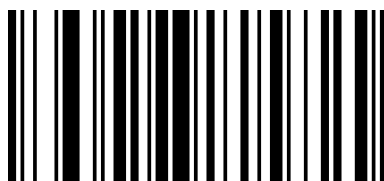

00620

Disable Code 93

Code 128

Enable/Disable Code 128

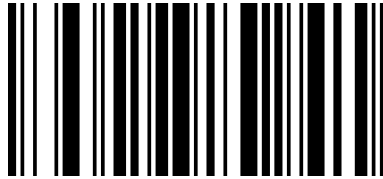

00691

Enable Code 128*

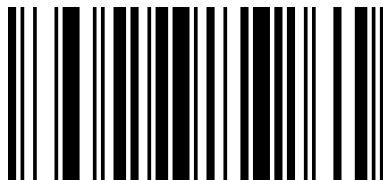

00690

Disable Code 128

GS1 DataBar Limited (RSS Limited)

Enable/Disable RSS Limited

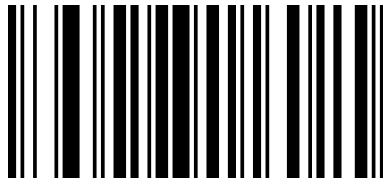

01771

Enable RSS Limited

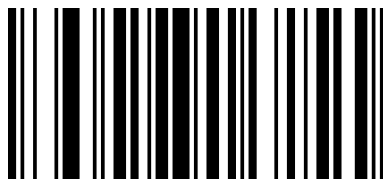

01770

Disable RSS Limited

GS1 DataBar Omnidirectional (RSS Omnidirectional)

Enable/Disable RSS Omnidirectional

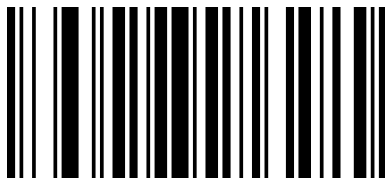

01671

Enable RSS Omnidirectional

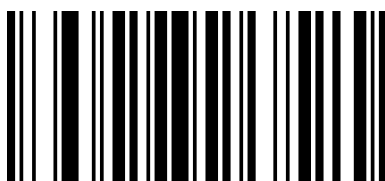

01670

Disable RSS Omnidirectional*

UPC-A

Enable/Disable UPC-A

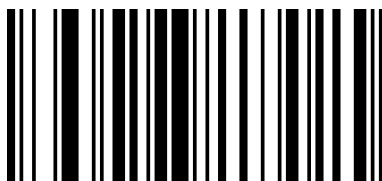

00341

Enable UPC-A*

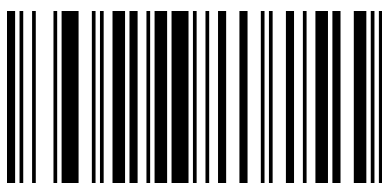

00340

Disable UPC-A*

Transmit Check Digit

UPC-A is 12 digits in length with the last one as its check digit used to verify the integrity of the data. The default mode opens “Transmit UPC-A Check Digit”. Users can choose to send it or not.

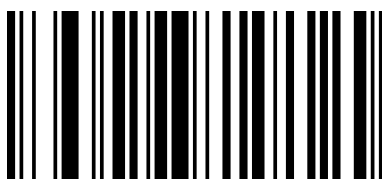

00421

Transmit UPC-A Check Digit*



00420

Transmit UPC-A Check Digit

Add-On Code

A UPC-A barcode can be augmented with a two-digit or five-digit add-on code to form a new one. In the examples below, the part surrounded by blue dotted line is a UPC-A barcode while the part circled by red dotted line is add-on code. Users can take “Add-On Code Setting” for reference.

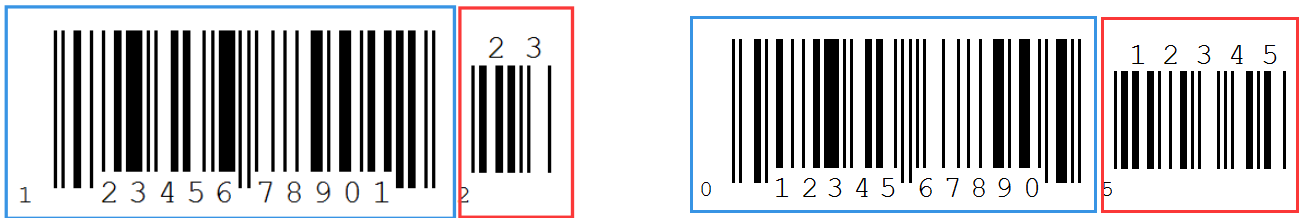

UPC-A transfer toEAN-13

Users can set to transfer UPC-A to EAN-13 according to your needs. The default closes this mode.

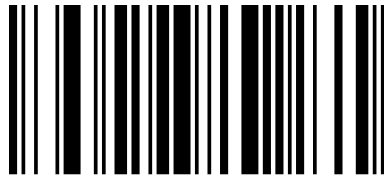

00391

Enable UPC-A Transfer toEAN13

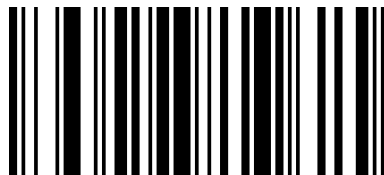

00390

Disable UPC-A Transfer toEAN13*

UPC-E

Enable/Disable UPC-E

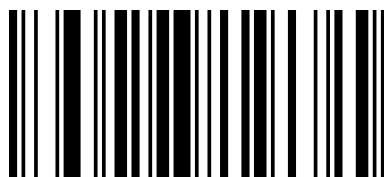

00351

Enable UPC-E

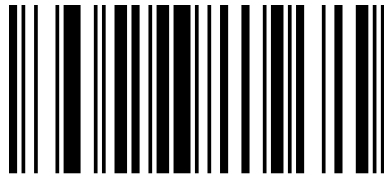

00350

Disable UPC-E

Transmit Check Digit

In the examples below, the part surrounded by blue dotted line is a UPC-A barcode while the part circled by red dotted line is add-on code. Users can take “Add-On Code Setting” for reference.

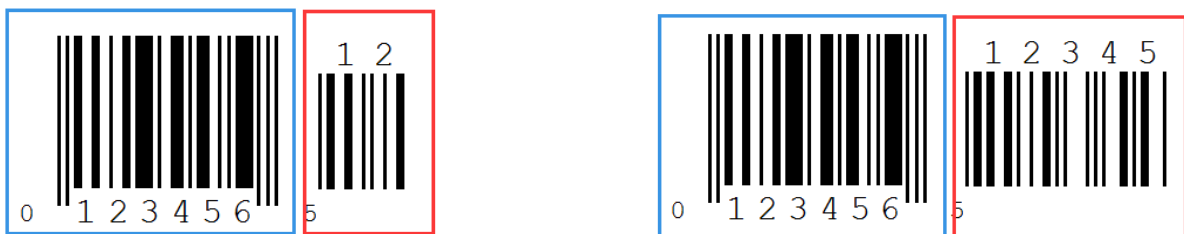

UPC-E transfer to UPC-A

Users can set to transfer UPC-E to UPC-A according to your needs. The default closes this mode.

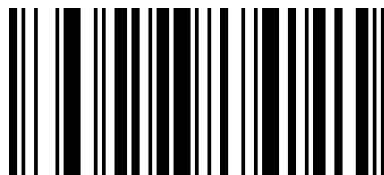

00381

Enable UPC-E Transfer to UPC-A

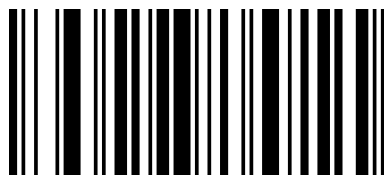

00380

Disable UPC-E Transfer to UPC-A*

Interleaved 2 of 5

Enable/Disable Interleaved 2 of 5

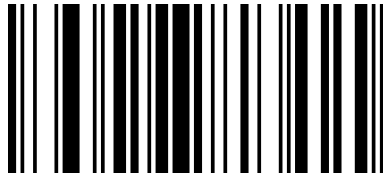

00961

Enable Interleaved 2 of 5*

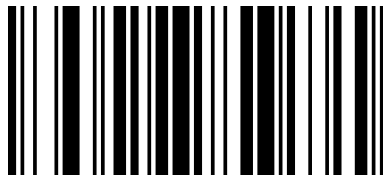

00960

Disable Interleaved 2 of 5

Industrial 2 of 5

Enable/Disable Industrial 2 of 5



01061

Enable Industrial 2 of 5*

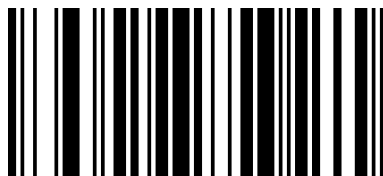

01060

Disable Industrial 2 of 5

Standard 2 of 5

Enable/DisableStandard 2 of 5

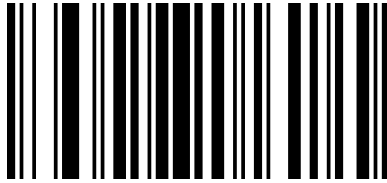

01871

Enable Standard 2 of 5*

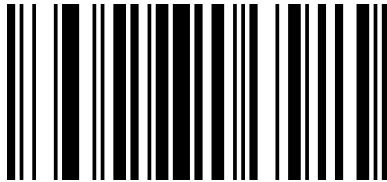

01870

DisableStandard 2 of 5

Matrix 2 of 5

Enable/DisableMatrix 2 of 5



01461

EnableMatrix 2 of 5*

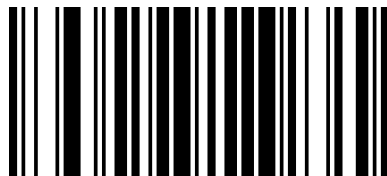

01460

DisableMatrix 2 of 5

MSI

Enable/DisableMSI

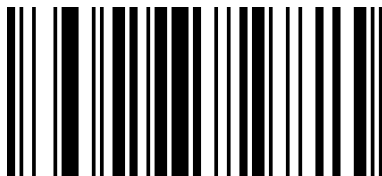

01151
EnableMSI



01150
Disable MSI*

Plessey

Enable/DisablePlessey



01161
EnablePlessey

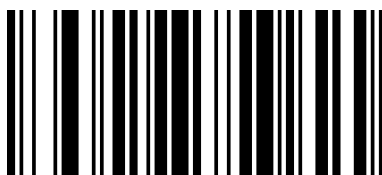

01160
DisablePlessey*

Add-On Code Setting

Users can scan the code below to open or close the setting of UPC/EAN/JAN.

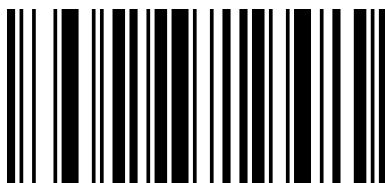

00551

Enable 2-Digit Add-On Code



00552

Enable 5-Digit Add-On Code



00553

Enable 2&5-Digit Add-On Code

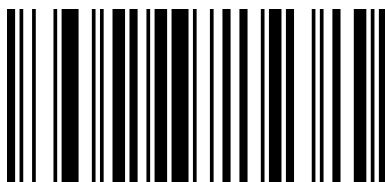

00550

Disable Digit Add-On Code*

Chapter 7 Serial Commands

Introduction

When the scanner apply to Serial Mode, users can send the corresponding command to control the scanner to scan or set some other functions.

A frame of serial port command is 16 bit(16bytes, 1byte=8bit).

Frame Format Structure

The frame format of serial command listed below:

STX+CMD+DA0+DA1+DA2+DA3+DA4+DA5+DA6+·····+DA10+DA11+ETX+SUM

In order to ensure the accuracy of the information, the last bit of the frame of the information(Hex) is check sum, let' s suppose the sum of previous 15 bits is a, then $SUM=256-(a\&0xFF)$.

where:

STX=0x02; ETX=0x03 (STX and ETX derive from ASCII Table)

CMD refers to command controlling or command setting

Command Analysis

When CMD=0x01, It refers to command controlling.

DA0=0x01, it can control scanner to enable command, and control to enable or disable the decoding function of the scanner

DA1=0x00, disable the scanner (disable decoding function of the scanner)

DA1=0x01, enable the scanner (no time delay when enable decoding, the Red LED light will always on until the decoding is done)

DA1=0x02, enable the scanner(enable decoding and have time delay)

DA2~DA3, time delay, unit: 1ms (0xDA3 0xDA2)

When CMD=0x02, it refers to command setting

DA0, it refers to set the effective bit +1 bit (e.g. If the version setting code is set to 000A0, the length is 5 bits, then DA0=6)

DA1, fixed to :0x82

DA2~DA11, it refers to the content of the setting code (to set the coding of the barcode) add 0x00 when the bit of DA2 is not enough.

Save Command

When users send command to set the corresponding scanner parameter, they need to send a command to save the setting after finishing the command setting.

STX	CMD	DA0	DA1	DA2	DA3	DA4~DA10	DA11	ETX	SUM
02H	01H	03H	AAH	55H	00H	00H~00H	00H	03H	F8H

Hex to Save Command: 02 01 03 AA 55 00 00 00 00 00 00 00 00 00 03 F8

Command Feedback Setting

When you enable command feedback (scan programming code 02421, or send a serial command to enable), if you set it successfully, then it will response a ACK(ASCII :0x06), if you don't set it successfully, then it will response a NAK(ASCII:0x15).

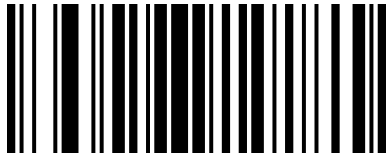

02421

Enable Command Feedback

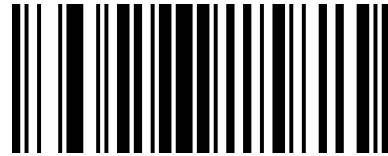

02420

Disable Command Feedback*

Buzzer feedback Setting

When you enable buzzer feedback (Scan programming code 01411, or send a serial command to enable), if you set it successfully, then buzzer will ring once.

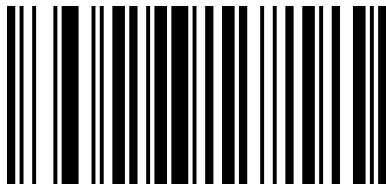

01411

Enable Buzzer Feedback

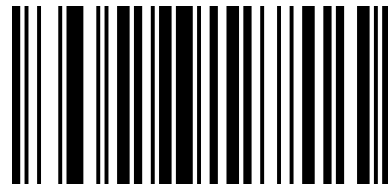

01410

Disable Buzzer Feedback*

Example Analysis

Disable decoding

CMD=0x01, DA0=0x01, DA1=0x00, DA2~DA11=0x00,

$a=(0)*16+(2+1+1+3)*1=7=0x07$

$SUM=256-(0x07\&FF)=256-(111\&11111111)=256-7=249=0xF9$

STX	CMD	DA0	DA1	DA2	DA3	DA4~DA10	DA11	ETX	SUM
02H	01H	01H	00H	00H	00H	00H~00H	00H	03H	F9H

Hex Command:02 01 01 00 00 00 00 00 00 00 00 00 00 00 03 F9

Enable decoding time delay 3 seconds

CMD=0x01, DA0=0x01, DA1=0x02, DA2=B8, DA3=0B, DA4~DA11=0x00,

Time delay3S=3000MS=0x0BB8

$a=(B)*16+(2+1+1+2+8+B+3)*1=204=0xCC$

$SUM=256-(0xCC\&FF)=256-(11001100\&11111111)=256-204=52=0x34$

STX	CMD	DA0	DA1	DA2	DA3	DA4~DA10	DA11	ETX	SUM
02H	01H	01H	02H	B8H	0BH	00~00H	00H	03H	34H

Hex Command: 02 01 01 02 B8 0B 00 00 00 00 00 00 00 03 34

Serial Baud Rate Setting 115200

Command Number Setting: 000709

CMD=0x02, DA0=0x07, DA1=0x82,

DA2~DA7=000709=0x30,0x30,0x30,0x30,0x37,0x30,0x39

$a=(8+3+3+3+3+3+3)*16+(2+2+7+2+9+5+3)*1=448=0x1c0$

$SUM=256-(0x1c0\&FF)=256-(111000000\&11111111)=256-192=64=0x40$

STX	CMD	DA0	DA1	DA2	DA3	DA4	DA5	DA6	DA7	DA8~DA11	ETX	SUM
02H	02H	07H	82H	30H	30H	30H	37H	39H	35H	00H~00H	03H	40H

Hex Command: 02 02 07 82 30 30 30 37 30 39 00 00 00 00 03 40

Add Return and Newline

Command Number Setting: 0213@\r\n

CMD=0x02, DA0=0x08, DA1=0x82,

DA2~DA8=0213@\r\n =0x30,0x32,0x31,0x33,0x40,0x0D,0x0A

$a=(8+3+3+3+3+4)*16+(2+2+8+2+2+1+3+13+10+3)*1=430=0x1ae=256-(0x1ae\&0xFF)=256-(110101110\&11111111)=256-(10101110)=256-174=82=0x52$

STX	CMD	DA0	DA1	DA2	DA3	DA4	DA5	DA6	DA7	DA ₈	DA9~DA11	ETX	SUM
02H	02H	08H	82H	30H	32H	31H	33H	40H	0DH	0AH	00H~00H	03H	52H

Hex Command: 02 02 08 82 30 32 31 33 40 0D 0A 00 00 00 03 52

An example of sending a command

To Click “Send as hex” to control the process of scanning, remember to confirm the default setting of serial port communication as below, and send the command in command area, then click “Send” command to start scanning.

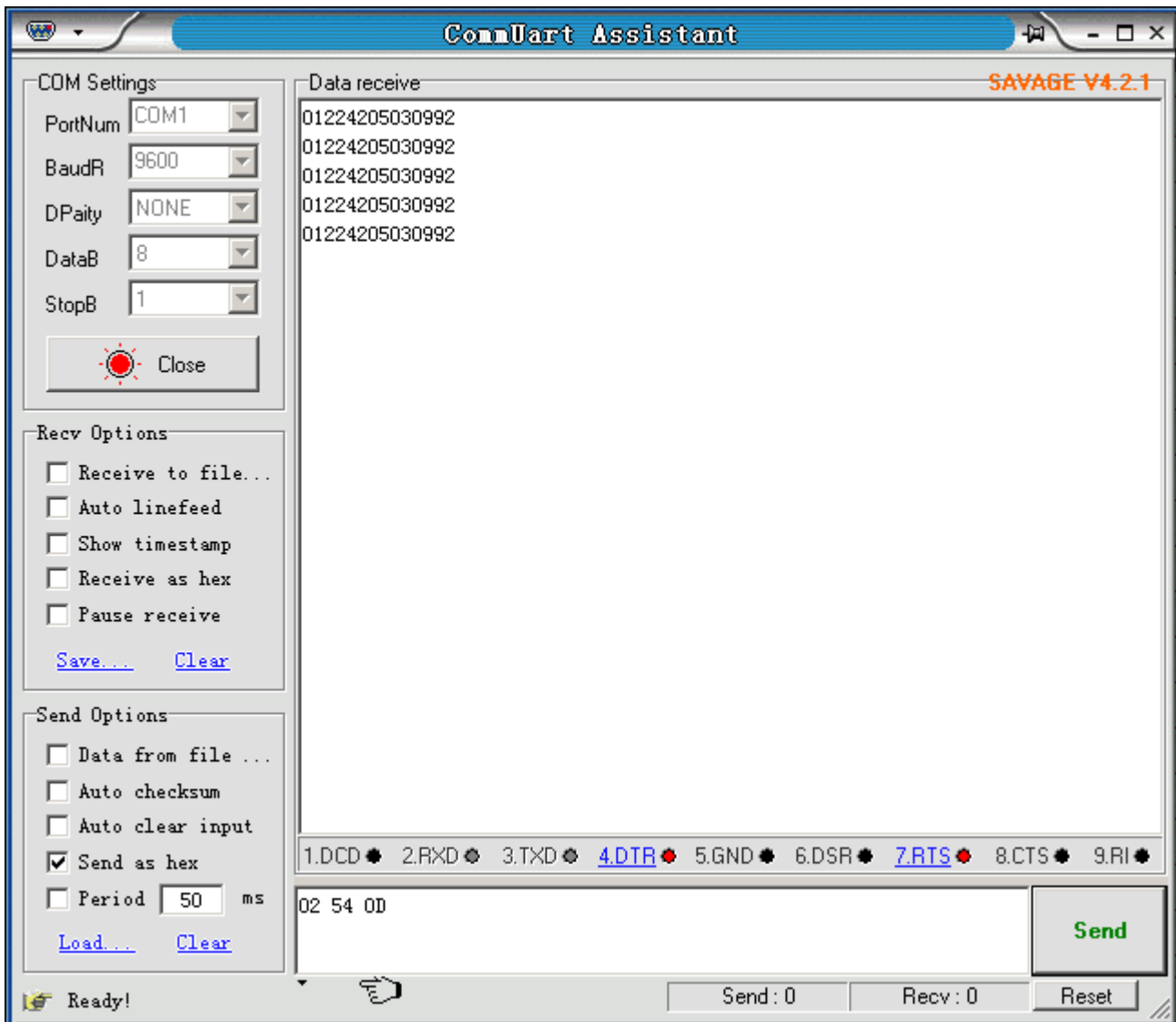

Chapter 8 Appendix

Appendix A

No	Code ID	Type of Code(For Prefix	Symbology
1	@	00	All Symbologies
2	A	01	CODE 128
3	C	03	EAN 8
4	D	04	EAN 13
5	E	05	UPC-A
6	F	06	UPC-E
7	I	09	CODE 93
8	J	0A	GS1 Omnidirectional
9	K	0B	GS1 Limited
10	M	0D	CODE 39
11	N	0E	Interleaved 2 of 5
12	O	0F	Industrial 2 of 5
13	P	10	Standard 2 of 5
14	Q	11	Matrix 2 of 5
15	S	13	MSI
16	T	14	Plessey
17	U	15	CODE 11
18	V	16	Codebar

Appendix B (ASCII Table)



1001
SOH (01)



1004
EOT (04)



1007
BEL (07)



1010
LF (0A)



1013
CR (0D)



1016
DEL (10)



1019
DC3 (13)



1022
SYN (16)



1002
STX (02)



1005
ENQ (05)



1008
Backspace (08)



1011
VT (0B)



1014
SO (0E)



1017
DC1 (11)



1020
DC4 (14)



1023
ETB (17)



1003
ETX (03)



1006
ACK (06)



1009
HT (09)



1012
FF (0C)



1015
SI (0F)



1018
DC2 (12)



1021
NAK (15)



1024
CAN (18)



1025
EM (19)



1028
FS (1C)



1031
US (1F)



1034
" (22)



1037
% (25)



1040
((28)



1043
+ (2B)



1046
. (2E)



1026
SUB (1A)



1029
GS (1D)



1032
Space (20)



1035
(23)



1038
& (26)



1041
) (29)



1044
, (2C)



1047
/ (2F)



1027
ESC (1B)



1030
RS (1E)



1033
! (21)



1036
\$ (24)



1039
' (27)



1042
* (2A)



1045
- (2D)



1048
0 (30)

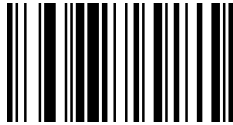

1049
1 (31)

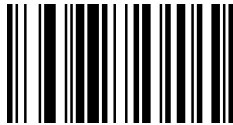

1052
4 (34)



1055
7 (37)



1058
: (3A)

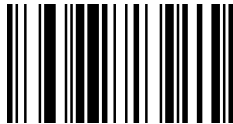

1061
= (3D)

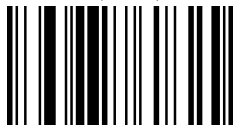

1064
@ (40)



1067
C (43)



1070
F (46)

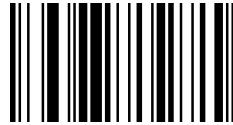

1050
2 (32)



1053
5 (35)



1056
8 (38)



1059
; (3B)



1062
> (3E)

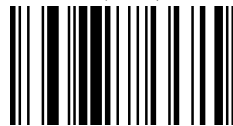

1065
A (41)



1068
D (44)



1071
G (47)



1051
3 (33)

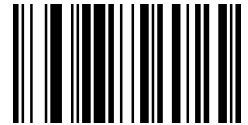

1054
6 (36)



1057
9 (39)



1060
< (3C)

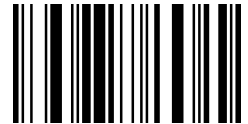

1063
? (3F)

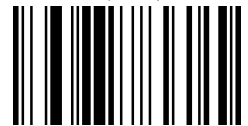

1066
B (42)



1069
E (45)



1072
H (48)

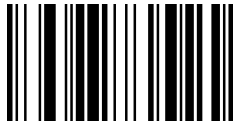

1073
I (49)



1076
L (4C)



1079
O (4F)

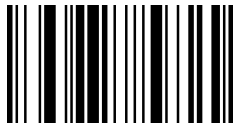

1082
R (52)

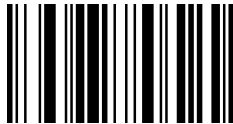

1085
U (55)

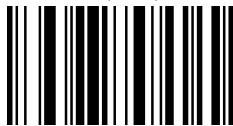

1088
X (58)



1091
[(5B)



1094
^ (5E)

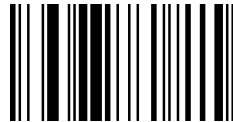

1074
J (4A)



1077
M (4D)



1080
P (50)



1083
S (53)

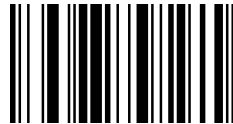

1086
V (56)

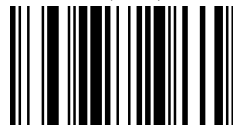

1089
Y (59)



1092
\ (5C)



1095
_ (5F)

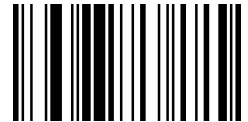

1075
K (4B)

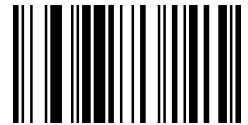

1078
N (4E)

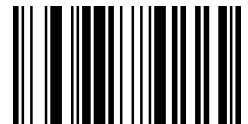

1081
Q (51)



1084
T (54)

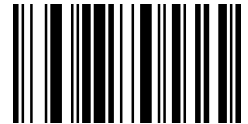

1087
W (57)



1090
Z (5A)

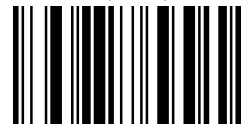

1093
] (5D)



1096
` (60)



1097
a (61)



1098
b (62)



1099
c (63)

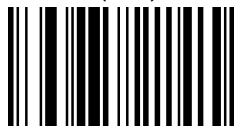

1100
d (64)



1101
e (65)



1102
f (66)



1103
g (67)



1104
h (68)



1105
i (69)



1106
j (6A)

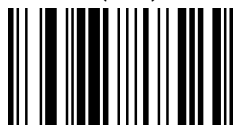

1107
k (6B)



1108
l (6C)



1109
m (6D)



1110
n (6E)



1111
o (6F)



1112
p (70)



1113
q (71)



1114
r (72)



1115
s (73)



1116
t (74)



1117
u (75)



1118
v (76)



1119
w (77)



1120
x (78)



1121
y (79)



1124
| (7C)



1127
Delete (7F)



1122
z (7A)



1125
} (7D)

























1123
{ (7B)



1126
~ (7E)

Appendix C (Function Key Table)

 1128 F1 (80)	 1129 F2 (81)	 1130 F3 (82)
 1131 F4 (83)	 1132 F5 (84)	 1133 F6 (85)
 1134 F7 (86)	 1135 F8 (87)	 1136 F9 (88)
 1137 F10 (89)	 1138 F11 (8A)	 1139 F12 (8B)
 1140 Insert (8C)	 1141 Home (8D)	 1142 Page UP (8E)
 1143 Delete (8F)	 1144 End (90)	 1145 Page Down (91)
 1146 Right arrow (92)	 1147 Left arrow (93)	 1148 Down arrow (94)
 1149 Up arrow (95)		